

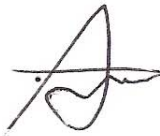





# APPROVAL SHEET

Product	Battery Protect Solution IC
Product code	<b>MP44A</b> ( 001-MP44A-00 )
Production Form	TEP - 5L, BD62
Date of Registration	July. 19. 2010

	Issued	Checked	Checked	Approved
결 재				
	H.M Jo	S.W Park	S.H Ahn	Y.S Kim

	품 질	기 술		
협 의				
	6/14	6/14		



**ITM Semiconductor Co., LTD**

1112-8, Namchon-Ri, Oksan-Myon, Cheonwon-Gun,  
Chungcheongbuk-Do, Korea 363-911

TEL +82 - 43 - 270 - 4816

FAX +82 - 43 - 270 - 4923

HOME <http://www.it-m.co.kr>

## **Contents**

---

1. Features .....	Page 1
2. Outline .....	Page 2
3. Pin Assignment .....	Page 3
4. Block Diagram .....	Page 3
5. Absolute Maximum Rating .....	Page 4
6. Electrical Characteristics .....	Page 4
7. Measuring Circuit .....	Page 9
8. Operation .....	Page 10
1) Overcharge detector (VD1) .....	Page 10
2) Overdischarge detector (VD2) .....	Page 10
3) Discharge overcurrent detector, Short detector (VD3, Short Detector) .....	Page 11
4) Charger overcurrent detector .....	Page 11
9. Application Circuit .....	Page 12
10. Timing Chart .....	Page 13
11. Packing spec .....	Page 15
12. Package Description .....	Page 17
13. Marking Contents .....	Page 18

## Features

1. The protection IC and The Dual-Nch MOSFET to use common Drain are integrated into One-packaging IC.

2. Reduced Pin-Count by fully connecting internally.

3. Application Part

1) Protection IC

① Uses high withstand voltage CMOS process.

- The charger section can be connected up to absolute maximum rating 28V.

② Detection voltage precision

- Overcharge detection voltage

$\pm 25\text{mV}$  (Ta=25°C),  $\pm 45\text{mV}$  (Ta=-30~70°C)

- Overdischarge detection voltage

$\pm 55\text{mV}$  (Ta=25°C),  $\pm 75\text{mV}$  (Ta=-30~70°C)

- Discharging overcurrent detection voltage

$\pm 10\text{mV}$  (Ta=25°C),  $\pm 20\text{mV}$  (Ta=-30~70°C)

- Charging overcurrent detection voltage

$\pm 20\text{mV}$  (Ta=25°C),  $\pm 40\text{mV}$  (Ta=-30~70°C)

③ Built-in detection delay times

- Overcharge detection delay time

$1.00 \pm 0.20\text{s}$  (Ta=25°C),  $1.00[+0.50, - 0.40]\text{s}$  (Ta=-30~70°C)

- Overdischarge detection delay time)

$20.0 \pm 4.0\text{ms}$  (Ta=25°C),  $20.0[+10.0, - 8.0]\text{ms}$  (Ta=-30~70°C)

- Discharging overcurrent detection delay time)

$12.0 \pm 2.4\text{ms}$  (Ta=25°C),  $12.0[+6, - 4.8]\text{ms}$  (Ta=-30~70°C)

- Charging overcurrent detection delay time)

$16.0 \pm 3.2\text{ms}$  (Ta=25°C),  $16.0[+8.0, - 6.4]\text{ms}$  (Ta=-30~70°C)

- Short detection delay time)

$400[+160, - 120]\mu\text{s}$  (Ta=25°C),  $400[+400, - 200]\mu\text{s}$  (Ta=-30~70°C)

④ 0V charge function is allowed

⑤ Auto Wake-up function is allowed

2) FET

① Using advanced trench technology to provide excellent  $R_{DS(ON)}$ , low gate charge and operation with gate voltage as low as 2.5V while retaining a 12V  $V_{GS(MAX)}$ .

② The protection for ESD

③ Common drain configuration

④ General characteristics

-  $V_{DS}$  (V) = 24V

-  $I_D$  (A) = 7A

-  $R_{SS(ON)} < 47\text{m}\Omega$  ( $V_{GS} = 3.9\text{V}$ ,  $I_D = 1\text{A}$ )

- ESD Rating : 2000V HBM

## Outline

This is a battery protect solution IC which is integrated with built-in the protection IC to use a lithium ion/lithium polymer secondary batteries developed for 1-cell series and Dual-Nch MOSFET. It functions to protect the battery by detecting overcharge, overdischarge, discharge overcurrent, charge overcurrent and other abnormalities as turning off internal Nch MOSFET. The protection IC is composed of four voltage detectors, short detection circuit, reference voltage sources, oscillator, counter circuit and logical circuits.

The C<sub>OUT</sub> pin (charge FET control pin) and D<sub>OUT</sub> pin (discharge FET control pin) outputs are CMOS output, and can drive the internal Nch MOSFET directly. The C<sub>OUT</sub> output becomes low level after delay time fixed in the IC if overcharge is detected. The D<sub>OUT</sub> output becomes low level after delay time fixed in the IC if overdischarge, discharge overcurrent or short is detected.

On overcharge state, if the V<sub>DD</sub> voltage is less than the overcharge release voltage, the C<sub>OUT</sub> output becomes high level after delay time fixed in the IC. On overdischarge state, if the voltage of the battery rises more than the overdischarge detection voltage with connecting the charger, the D<sub>OUT</sub> output becomes high level after delay time fixed in the IC. Charging current can be supplied to the battery discharged up to 0V.

Once discharge overcurrent or short have been detected, if the state of discharge overcurrent or short is released by opening the loads, the D<sub>OUT</sub> output becomes high level after delay time fixed in the IC. On overdischarge state, the supply current is reduced as less as possible. Once charge overcurrent has been detected, the state of charge overcurrent is released by opening the charger and setting the load.

## Pin Assignment

[ Package: TEP-5L ]

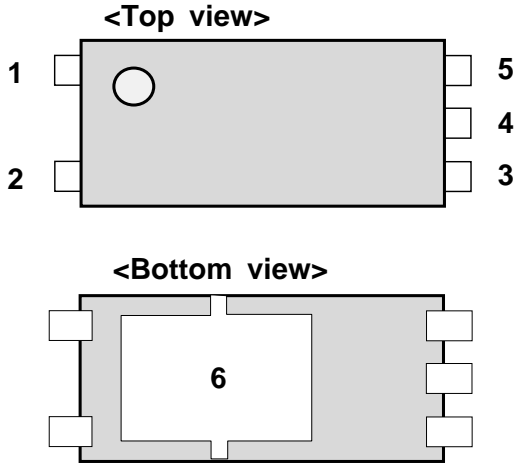

1	N.C
2	Source 1(same as $V_{SS}$ )
3	Source 2
4	$V_{DD}$
5	$V_{-}$
6	Drain

## Block Diagram

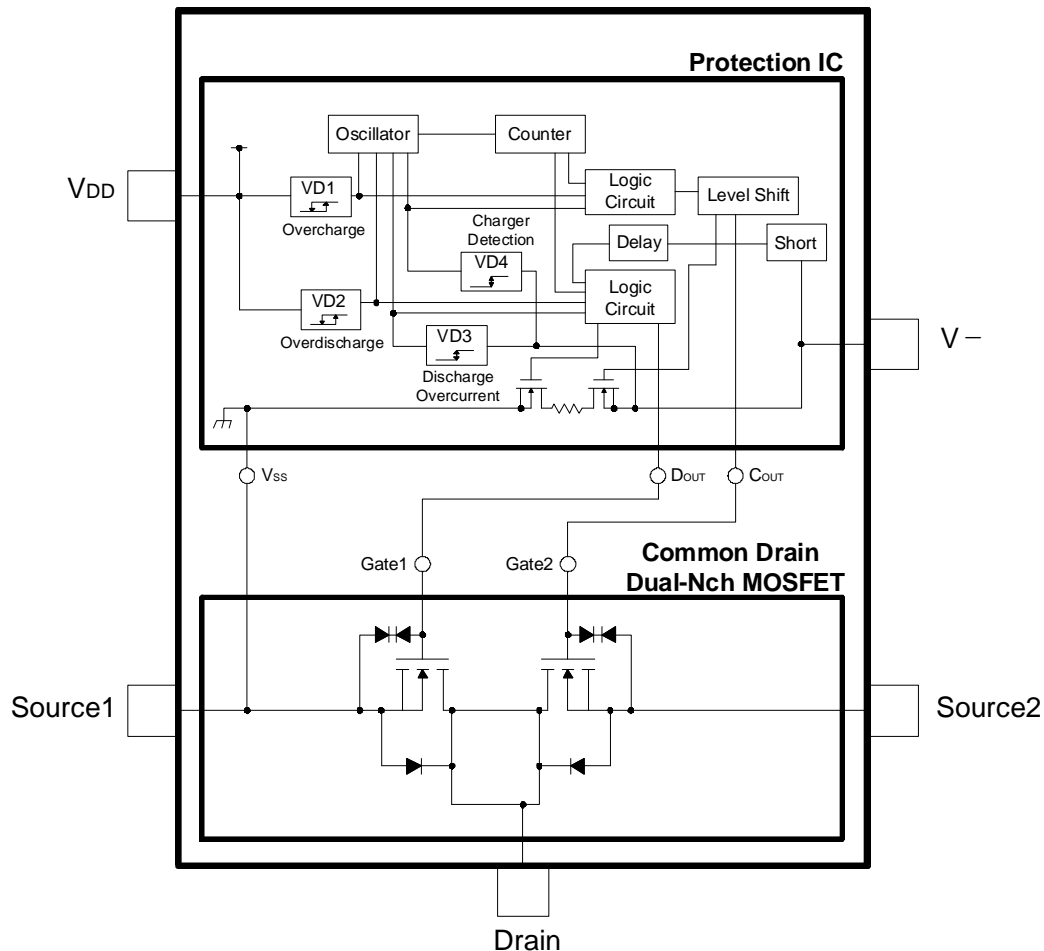

## Absolute Maximum Rating

 ※  $T_{OPR}=25^{\circ}\text{C}$ , Source1( $V_{SS}$ )=0V

Item	Symbol	Rating	Unit
Supply Voltage	$V_{DD}$	-0.3 ~ 12	V
V- Terminal Input Voltage	V-	$V_{DD}-28 \sim V_{DD}+0.3$	V
C <sub>OUT</sub> Terminal Output Voltage	$V_{COUT}$	$V_{DD}-28 \sim V_{DD}+0.3$	V
D <sub>OUT</sub> Terminal Output Voltage	$V_{DOUT}$	$V_{SS}-0.3 \sim V_{DD}+0.3$	V
Operation Temperature	$T_{OPR}$	-40 ~ +85	°C
Storage Temperature	$T_{STG}$	-55 ~ +125	°C
Drain-Source Voltage	$V_{DS}$	24	V
Gate-Source Voltage	$V_{GS}$	±12	V

## Electrical Characteristics

Item	Symbol	Measure Condition	Min.	Typ.	Max.	Unit	*1	
<b>Input Voltage</b>								
Operating Input Voltage	$V_{DD1}$	$V_{DD} - V_{SS}$	1.5	-	10.0	V	A	
Minimum Operating Voltage for 0V Charging	$V_{ST}$	$V_{DD} - V-$ , $V_{DD}-V_{SS}=0V$	-	-	1.2	V	A	
<b>Channel ON Voltage</b>								
C <sub>OUT</sub> Pin Nch ON Voltage	$V_{OL1}$	$I_{OL}=30\mu\text{A}$ , $V_{DD}=4.5V$	-	0.4	0.5	V	-	
C <sub>OUT</sub> Pin Pch ON Voltage	$V_{OH1}$	$I_{OH}=-30\mu\text{A}$ , $V_{DD}=3.9V$	3.4	3.7	-	V	-	
D <sub>OUT</sub> Pin Nch ON Voltage	$V_{OL2}$	$I_{OL}=30\mu\text{A}$ , $V_{DD}=2.0V$	-	0.2	0.5	V	-	
D <sub>OUT</sub> Pin Pch ON Voltage	$V_{OH2}$	$I_{OL}=-30\mu\text{A}$ , $V_{DD}=3.9V$	3.4	3.7	-	V	-	
<b>Current Consumption</b>								
Current Consumption	$I_{DD}$	$V_{DD}=3.9V$ , $V-=0V$	-	3.0	6.0	μA	L	
Current Consumption at Stand-By	$I_S$	$V_{DD}=2.0V$ , $T_{OPR}=25^{\circ}\text{C}$	-	-	0.5	μA	L	
<b>Over Charge Voltage Protection</b>								
Overcharge Detection Voltage	$V_{DET1}$	$R1=1.0k\Omega$	$T_{OPR}=25^{\circ}\text{C}$	4.250	4.275	4.300	V	B
			$T_{OPR}=-30\sim 70^{\circ}\text{C}$	4.230	4.275	4.320		
Overcharge Detection Delay Time	$tV_{DET1}$	$V_{DD}=3.6V \rightarrow 4.6V$	$T_{OPR}=25^{\circ}\text{C}$	0.80	1.00	1.20	s	B
			$T_{OPR}=-30\sim 70^{\circ}\text{C}$	0.60	1.00	1.50		
Overcharge Release Delay Time	$tV_{REL1}$	$V_{DD}=4.6V \rightarrow 3.6V$	$T_{OPR}=25^{\circ}\text{C}$	12.8	16.0	19.2	ms	B
			$T_{OPR}=-30\sim 70^{\circ}\text{C}$	9.6	16.0	24.0		

**Battery Protect Solution IC**

Item	Symbol	Measure Condition	Min.	Typ.	Max.	Unit	*1	
<b>Over Discharge Voltage Protection</b>								
Overdischarge Detection Voltage	V <sub>DET2</sub>	V <sub>-</sub> =0V R1=1.0kΩ	T <sub>OPR</sub> = 25℃	2.245	2.300	2.355	V	D
			T <sub>OPR</sub> = -30~70℃	2.225	2.300	2.375		
Overdischarge Detection Delay Time	tV <sub>DET2</sub>	V <sub>DD</sub> =3.6V→2.2V	T <sub>OPR</sub> = 25℃	16.0	20.0	24.0	ms	D
			T <sub>OPR</sub> = -30~70℃	12.0	20.0	30.0		
Overdischarge Release Voltage	V <sub>REL2</sub>	R1=1.0kΩ	T <sub>OPR</sub> = 25℃	2.625	2.700	2.775	V	D
			T <sub>OPR</sub> = -30~76℃	2.600	2.700	2.800		
Overdischarge Release Voltage 2	V <sub>REL2'</sub>	V <sub>chg</sub> = 4.2V R1=1.0kΩ R2=2.2kΩ	T <sub>OPR</sub> = 25℃	2.245	2.320	2.395	V	D
			T <sub>OPR</sub> = -30~70℃	2.225	2.320	2.415		
Overdischarge Release Delay Time	tV <sub>REL2</sub>	V <sub>DD</sub> =2.2V→3.6V	T <sub>OPR</sub> = 25℃	0.8	1.0	1.2	ms	E
			T <sub>OPR</sub> = -30~70℃	0.6	1.0	1.5		
<b>Discharge Overcurrent Protection</b>								
Discharging Overcurrent Detection Voltage	V <sub>DET3</sub>	V <sub>DD</sub> =3.5V R2=2.2kΩ	T <sub>OPR</sub> = 25℃	0.190	0.200	0.210	V	F
			T <sub>OPR</sub> = -30~70℃	0.180	0.200	0.220		
Discharging Overcurrent Detection Current	I <sub>DET3</sub>	V <sub>DD</sub> =3.9V R2=2.2kΩ	T <sub>OPR</sub> = 25℃	4.0	5.9	7.6	A	-
Discharging Overcurrent Detection Delay Time	tV <sub>DET3</sub>	V <sub>DD</sub> =3.5V V <sub>-</sub> =0V→1V	T <sub>OPR</sub> = 25℃	9.6	12.0	14.4	ms	F
			T <sub>OPR</sub> = -30~70℃	7.2	12.0	18.0		
Discharging Overcurrent Release Delay Time	tV <sub>REL3</sub>	V <sub>DD</sub> =3.5V V <sub>-</sub> =3V→0V	T <sub>OPR</sub> = 25℃	0.8	1.0	1.2	ms	F
			T <sub>OPR</sub> = -30~70℃	0.6	1.0	1.5		
<b>Charge Overcurrent Protection</b>								
Charging Overcurrent Detection Voltage	V <sub>DET4</sub>	V <sub>DD</sub> =3.5V R2=2.2kΩ	T <sub>OPR</sub> = 25℃	-0.220	-0.200	-0.180	V	G
			T <sub>OPR</sub> = -30~70℃	-0.240	-0.200	-0.160		
Charging Overcurrent Detection Current	I <sub>DET4</sub>	V <sub>DD</sub> =3.9V R2=2.2kΩ	T <sub>OPR</sub> = 25℃	3.8	5.9	7.9	A	-
Charging Overcurrent Detection Delay Time	tV <sub>DET4</sub>	V <sub>DD</sub> =3.5V V <sub>-</sub> =0V→-1V	T <sub>OPR</sub> = 25℃	12.8	16.0	19.2	ms	G
			T <sub>OPR</sub> = -30~70℃	9.6	16.0	24.0		
Charging Overcurrent Release Delay Time	tV <sub>REL4</sub>	V <sub>DD</sub> =3.5V V <sub>-</sub> =-1V→0V	T <sub>OPR</sub> = 25℃	0.8	1.0	1.2	ms	G
			T <sub>OPR</sub> = -30~70℃	0.6	1.0	1.5		
<b>Short Protection</b>								
Short Detection Voltage	V <sub>SHORT</sub>	V <sub>DD</sub> =3.5V	T <sub>OPR</sub> = 25℃	0.8	0.9	1.0	V	F
			T <sub>OPR</sub> = -30~70℃	0.7	0.9	1.1		
Short Detection Current	I <sub>SHORT</sub>	V <sub>DD</sub> =3.9V	T <sub>OPR</sub> = 25℃	17.0	23.7	33.3	A	-
		V <sub>DD</sub> =3.5V	T <sub>OPR</sub> = 25℃	16.0	22.0	31.3		
Short Detection Delay Time	t <sub>SHORT</sub>	V <sub>DD</sub> =3.5V V <sub>-</sub> =0V→3.5V	T <sub>OPR</sub> = 25℃	280	400	560	μs	F
			T <sub>OPR</sub> = -30~70℃	200	400	800		

Note : \*1 The test circuit symbols.

\*2 The parameter is guaranteed by design.

## Battery Protect Solution IC

**MP44A**

Item	Symbol	Measure Condition	Min.	Typ.	Max.	Unit	*1
<b>Integrated MOSFET</b>							
Drain-Source Breakdown Voltage	$BV_{DSS}$	$I_D=250\mu A, V_{GS}=0V$	24	-	-	V	
Zero Gate Voltage Drain Current	$I_{DSS}$	$V_{DS}=20V, V_{GS}=0V$ $T_J=55^\circ C$	-	-	1	$\mu A$	
			-	-	5		
Gate-Body Leakage Current	$I_{GSS}$	$V_{DS}=0V, V_{GS}=\pm 10V$	-	-	10	$\mu A$	
Gate-Source Breakdown Voltage	$BV_{GSO}$	$V_{DS}=0V, I_G=\pm 250\mu A$	$\pm 12$	-	-	V	
Gate Threshold Voltage	$V_{GS(th)}$	$V_{DS}=V_{GS}, I_D=250\mu A$	0.6	1.0	1.5	V	
Static Source-Source ON-Resistance	$R_{SS(ON)}$	$V_{GS}=4.2V, I_D=1A$	29	37	46	$m\Omega$	
		$V_{GS}=3.9V, I_D=1A$	30	38	47	$m\Omega$	
		$V_{GS}=3.7V, I_D=1A$	31	39	48	$m\Omega$	
		$V_{GS}=3.5V, I_D=1A$	32	41	50	$m\Omega$	
		$V_{GS}=3.3V, I_D=1A$	33	43	52	$m\Omega$	
		$V_{GS}=3.0V, I_D=1A$	36	45	55	$m\Omega$	
Static Source-Source ON-Resistance	$R_{SS(ON)}$	$V_{GS}=2.5V, I_D=1A$	41	49	66	$m\Omega$	
Diode Forward Voltage	$V_{SD}$	$I_S=1A, V_{GS}=0V$	0.50	0.76	0.90	V	
Maximum Body-Diode Continuous Current	$I_S$				4.5	A	

Note : \*1 The test circuit symbols.

\*2 The parameter is guaranteed by design.



## Battery Protect Solution IC

**MP44A**

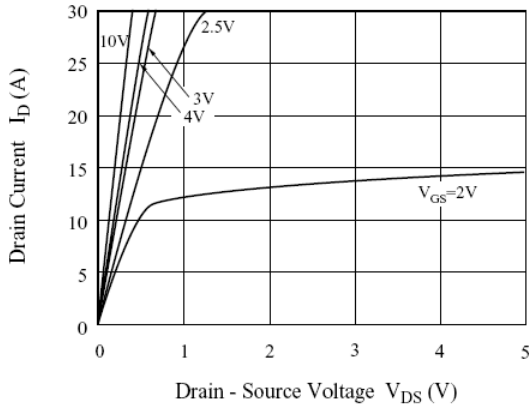
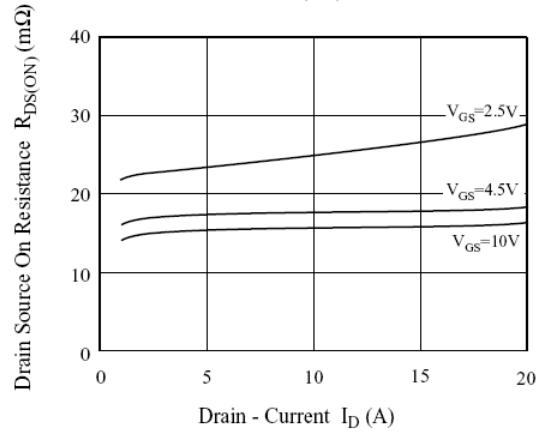
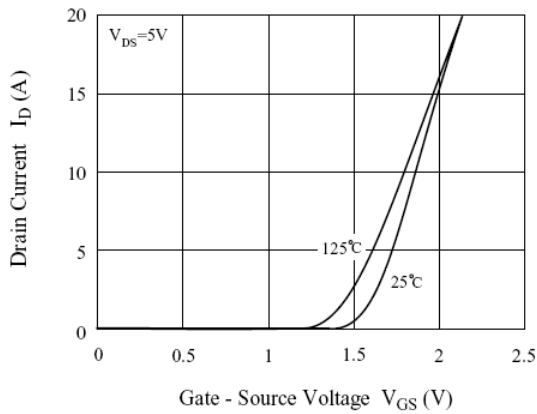
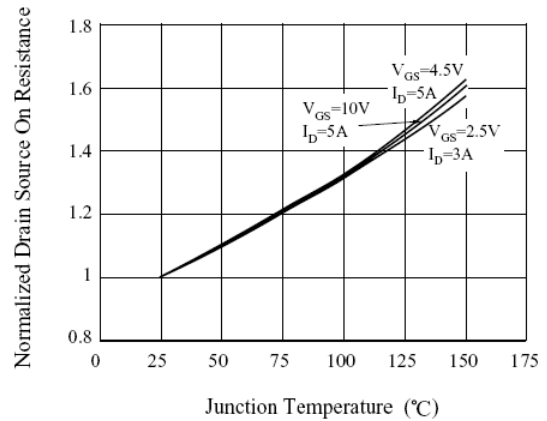
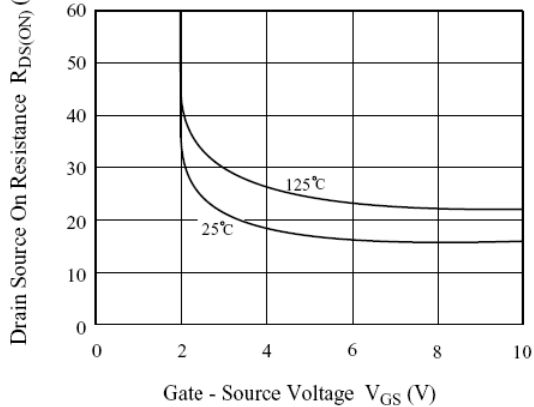
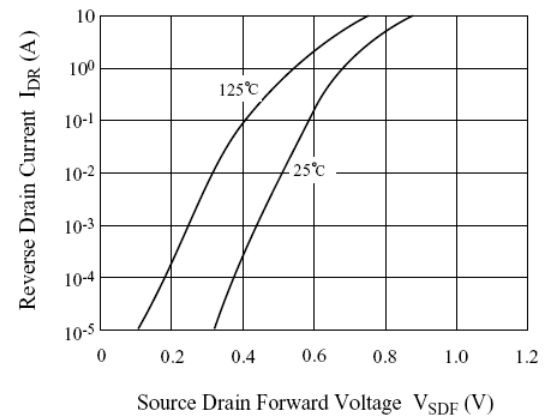
 Fig1.  $I_D - V_{DS}$ 

 Fig2.  $R_{DS(ON)} - I_D$ 

 Fig3.  $I_D - V_{GS}$ 

 Fig4.  $R_{DS(ON)} - T_j$ 

 Fig5.  $R_{DS(ON)} - V_{GS}$ 

 Fig6.  $I_{DR} - V_{SDF}$ 

**Battery Protect Solution IC**

Fig7.  $V_{GS} - Q_g$

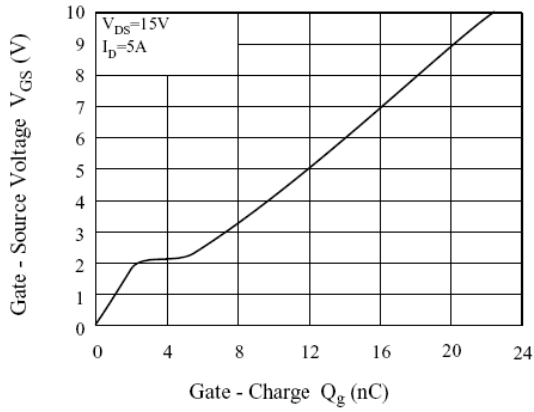
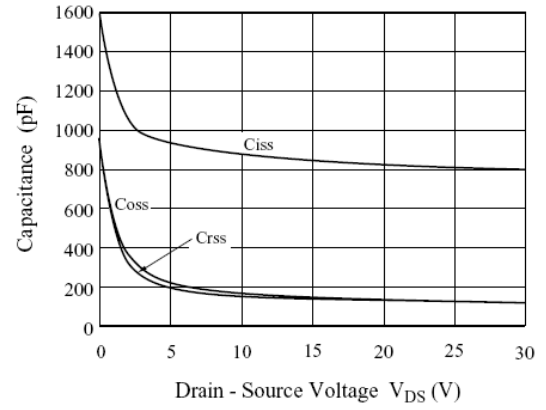
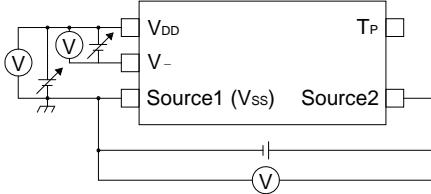

Fig8.  $C - V_{DS}$



## Measuring Circuit

A.



E.

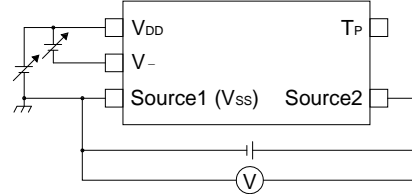

B.

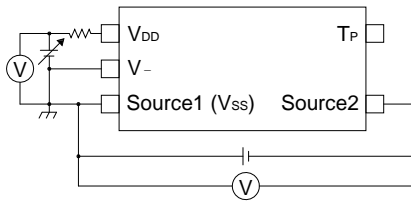

F.

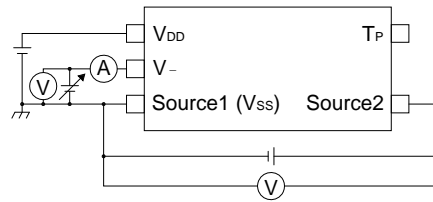

C.

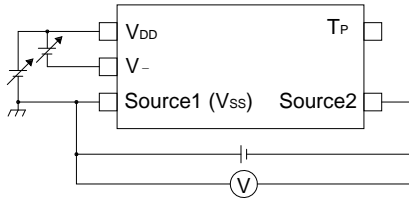

G.

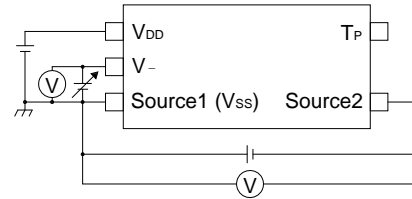

D.

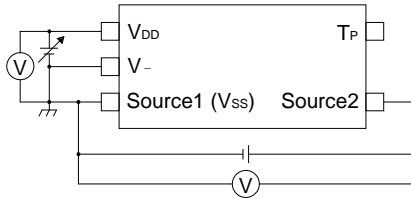

H.

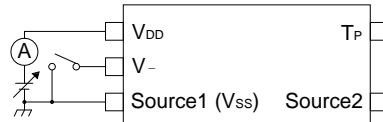

## Operation

### 1. Overcharge detector (VD1)

The VD1 monitors  $V_{DD}$  pin voltage during charge. In the state of charging the battery, it will detect the overcharge state of the battery if the  $V_{DD}$  terminal voltage becomes higher than the overcharge detection voltage (Typ. 4.275V). And then the  $C_{OUT}$  terminal turns to low level, so the internal charging control Nch MOSFET turns OFF and it forbids to charge the battery.

After detecting overcharge, it will release the overcharge state if the  $V_{DD}$  terminal voltage becomes lower than the overcharge release voltage. And then the  $C_{OUT}$  terminal turns to high level, so the internal charging control Nch MOSFET turns ON, and it accepts to charge the battery.

When the  $V_{DD}$  terminal voltage is higher than the overcharge detection voltage, to disconnect the charger and connect the load, leave the  $C_{OUT}$  terminal low level, but it accepts to conduct load current via the paracritical body diode of the internal Nch MOSFET. And then if the  $V_{DD}$  terminal voltage becomes lower than the overcharge detection voltage, the  $C_{OUT}$  terminal turns to high level, so the internal Nch MOSFET turn ON, and it accepts to charge the battery.

The overcharge detection and release have delay time decided internally. When the  $V_{DD}$  terminal voltage becomes higher than the overcharge detection voltage, if the  $V_{DD}$  terminal voltage becomes lower than the overcharge detection voltage again within the overcharge detection delay time (Typ. 1.00s), it will not detect overcharge. And in the state of overcharge, when the  $V_{DD}$  terminal voltage becomes lower than the overcharge release voltage, if the  $V_{DD}$  terminal voltage backs higher than the overcharge release voltage again within the overcharge release delay time (Typ. 16ms), it will not release overcharge.

The output driver stage of the  $C_{OUT}$  terminal includes a level shifter, so it will output the  $V_{DD}$  terminal voltage as low level. The output type of the  $C_{OUT}$  terminal is CMOS output between  $V_{DD}$  and  $V_{SS}$  terminal voltage.

### 2. Overdischarge detector (VD2)

The VD2 monitors  $V_{DD}$  pin voltage during discharge. In the state of discharging the battery, it will detect the overdischarge state of the battery if the  $V_{DD}$  terminal becomes lower than the overdischarge detection voltage (Typ. 2.300V). And then the  $D_{OUT}$  terminal turns to low level, so the internal discharging control Nch MOSFET turn OFF and it forbids to discharge the battery.

Once overdischarge has been detected, overdischarge is released and the  $D_{OUT}$  output becomes high level, if the voltage of the battery rises more than the overdischarge detection voltage with connecting the charger, or more than the overdischarge release voltage without connecting the charger. Charging current is supplied through a parasitic diode of Nch MOS FET when the  $V_{DD}$  terminal voltage is below the overdischarge detection voltage to the connection of the charger, and the  $D_{OUT}$  terminal enters the state which can be discharged by becoming high level, and turning on Nch MOS FET when the  $V_{DD}$  terminal voltage rises more than the overdischarge detection voltage.

When the battery voltage is about 0V, if the charger voltage is higher than the minimum operating voltage for 0V charging (Max. 1.2V), the  $C_{OUT}$  terminal outputs high level and it accepts to conduct charging current.

The overdischarge detection have delay time decided internally. When the  $V_{DD}$  terminal voltage becomes lower than the overdischarge detection voltage, if the  $V_{DD}$  terminal voltage becomes higher than the overdischarge detection voltage again within the overdischarge detection delay time (Typ. 20ms), it will not detect overdischarge. Moreover, the overdischarge release delay time (Typ. 1ms) exists, too.

All the circuits are stopped, and after the overdischarge is detected, it is assumed the state of the standby, and decreases the current (standby current) which IC consumes as much as possible. (When  $V_{DD}=2V$ , Max. 0.5uA).

The output type of the  $D_{OUT}$  terminal is CMOS output between  $V_{DD}$  and  $V_{SS}$  terminal voltage.

### 3. Discharge overcurrent detector, Short detector (VD3, Short Detector)

In the state of chargeable and dischargeable, VD3 monitors the voltage level of V. pin. If the V. terminal voltage becomes higher than the discharging overcurrent detection voltage (Typ. 0.200V) by short of loads, etc., it will detect discharging overcurrent state. If the V. terminal voltage becomes higher than short detection voltage (Typ. 0.9V), it will detect discharging overcurrent state, too. And then the  $D_{OUT}$  terminal outputs low level, so the internal discharging control Nch MOSFET turns OFF, and it protects from large current discharging.

The discharging overcurrent detection has delay time decided internally. When the V. terminal voltage becomes higher than the discharging overcurrent detection voltage, if the V. terminal voltage becomes lower than the discharging overcurrent detection voltage within the discharging overcurrent detection delay time (Typ. 12ms), it will not detect discharging overcurrent. Moreover, the discharging overcurrent release delay time (Typ. 1ms) exists, too.

The short detection delay time (Typ. 400us) decided internally exists, too.

The discharging overcurrent release resistance is built into between V. terminal and  $V_{SS}$  terminal. In the state of discharging overcurrent or short, if the load is opened, V. terminal is pulled down to the  $V_{SS}$  via the discharging overcurrent release resistance. And when the V. terminal voltage becomes lower than the discharging overcurrent detection voltage, it will automatically release discharging overcurrent or short state. If discharging overcurrent or short is detected, the discharging overcurrent release resistance turns ON. On the normal state (chargeable and dischargeable state), the discharging overcurrent release resistance is OFF.

### 4. Charge overcurrent detector (VD4)

In the state of chargeable and dischargeable, VD4 monitors the voltage level of V. pin. If the V. terminal voltage becomes lower than charging overcurrent detection voltage (Typ. -0.200V) by abnormal voltage or current charger, etc., it will detect charging overcurrent state. And then the  $C_{OUT}$  terminal outputs low level, so the internal charging control Nch MOSFET turn OFF, and it protects from large current charging.

It release charging overcurrent state if the abnormal charger is disconnected and the load is connected.

The charging overcurrent detection has delay time decided internally. When the V. terminal voltage becomes lower than the charging overcurrent detection voltage, if the V. terminal voltage becomes higher than the charging overcurrent detection voltage within the charging overcurrent detection delay time (Typ. 16ms), it will not detect charging overcurrent. Moreover, the charging overcurrent release delay time (Typ. 1ms) exists, too.

## Application Circuit (Example)

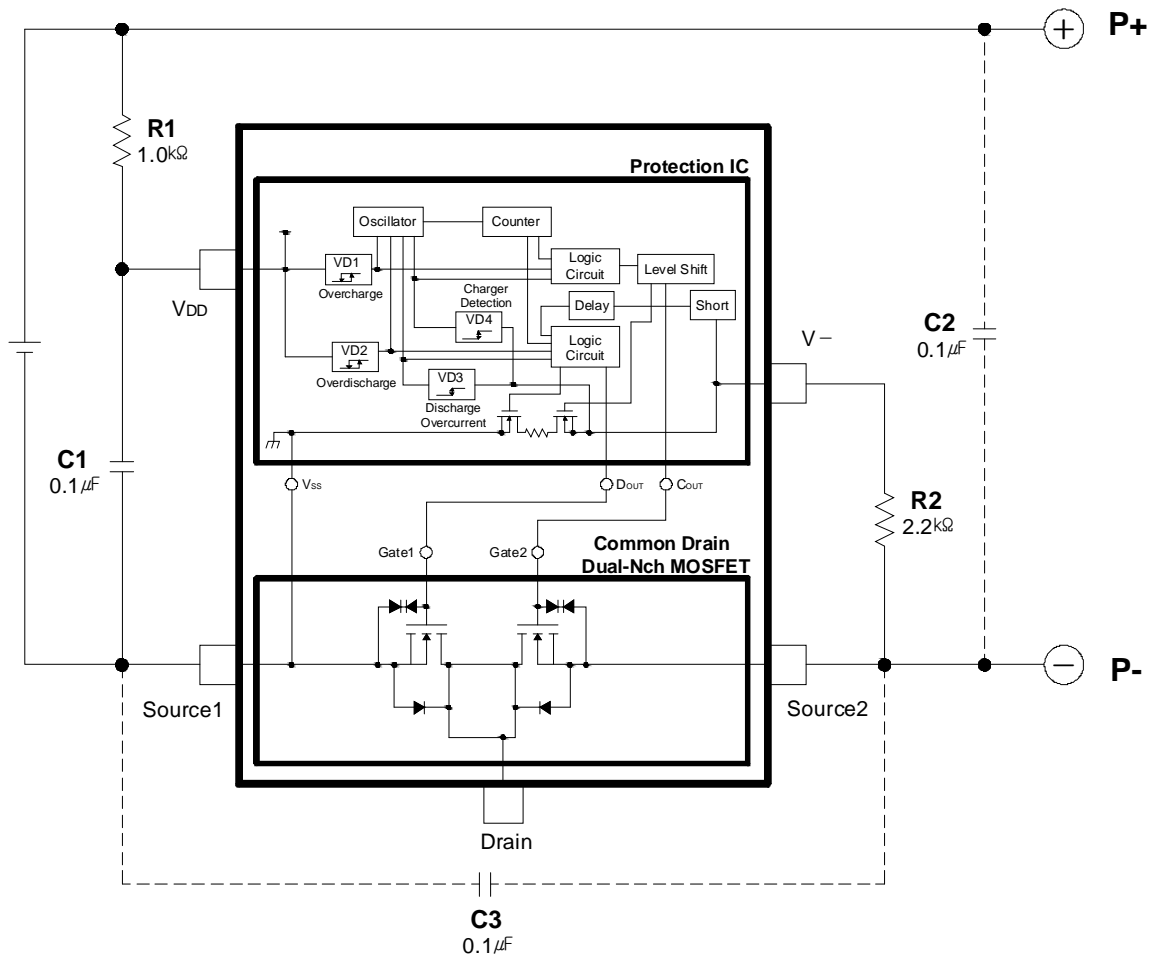

### ※ Application Hint

R1 and C1 stabilize a supply voltage ripple. However, the detection voltage rises by the current of penetration in IC of the voltage detection when R1 is enlarged, so the value of R1 is adjusted to 1kohm or less. Moreover, adjust the value of C1 to 0.01uF or more to do the stability operation, please.

R1 and R2 resistors are current limit resistance if a charger is connected reversibly or a highvoltage charger that exceeds the absolute maximum rating is connected. R1 and R2 may cause a power consumption will be over rating of power dissipation, therefore the `R1+R2` should be more than 1kohm. Moreover, if R2 is too enlarged, the charger connection release cannot be occasionally done after the overdischarge is detected, so adjust the value of R2 to 10kohm or less, please.

C2 and C3 capacitors have effect that the system stability about voltage ripple or imported noise. After check characteristics, decide that these capacitors should be inserted or not, where should be inserted, and capacitance value, please.

## Timing Chart

### 1. Overcharge, Charging overcurrent operations

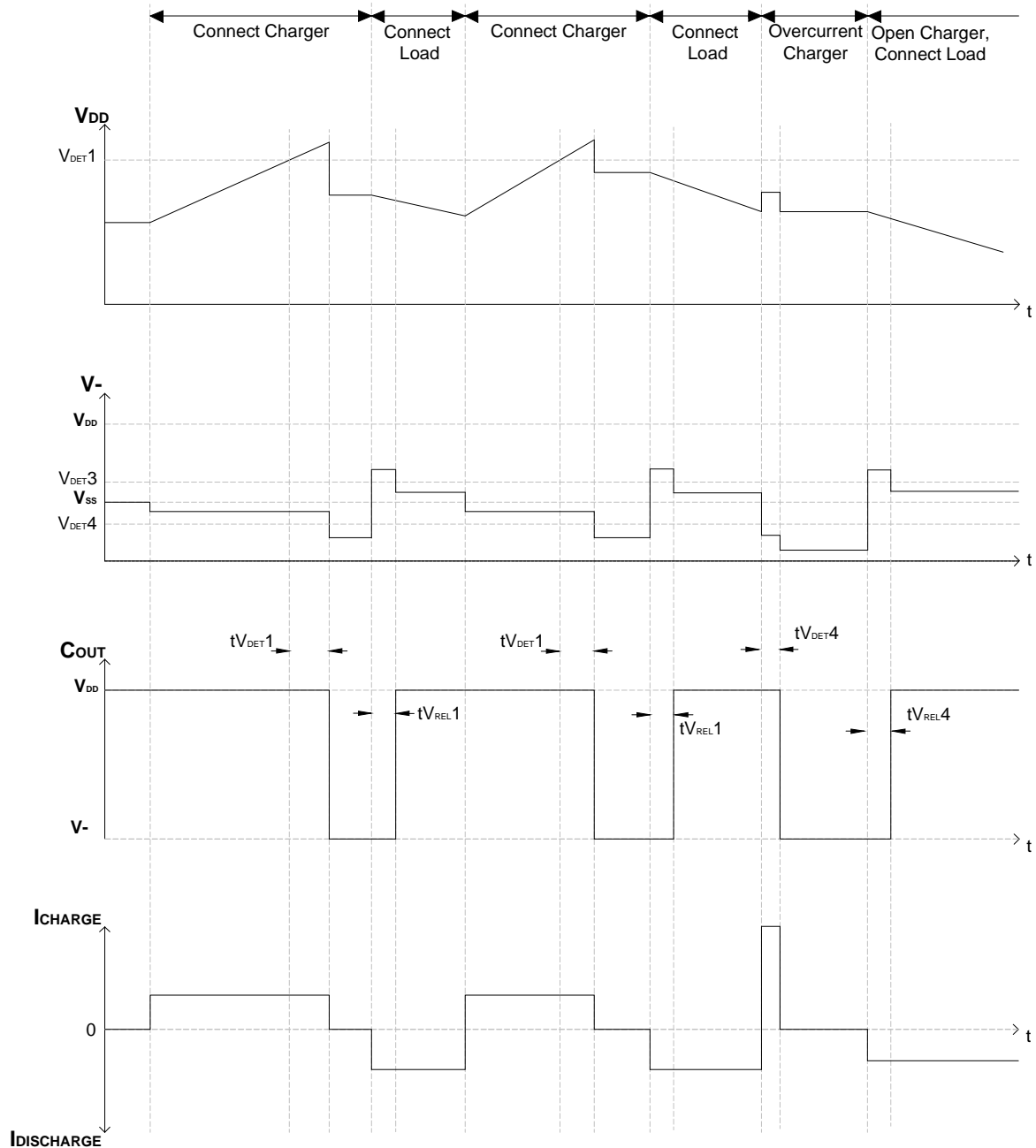

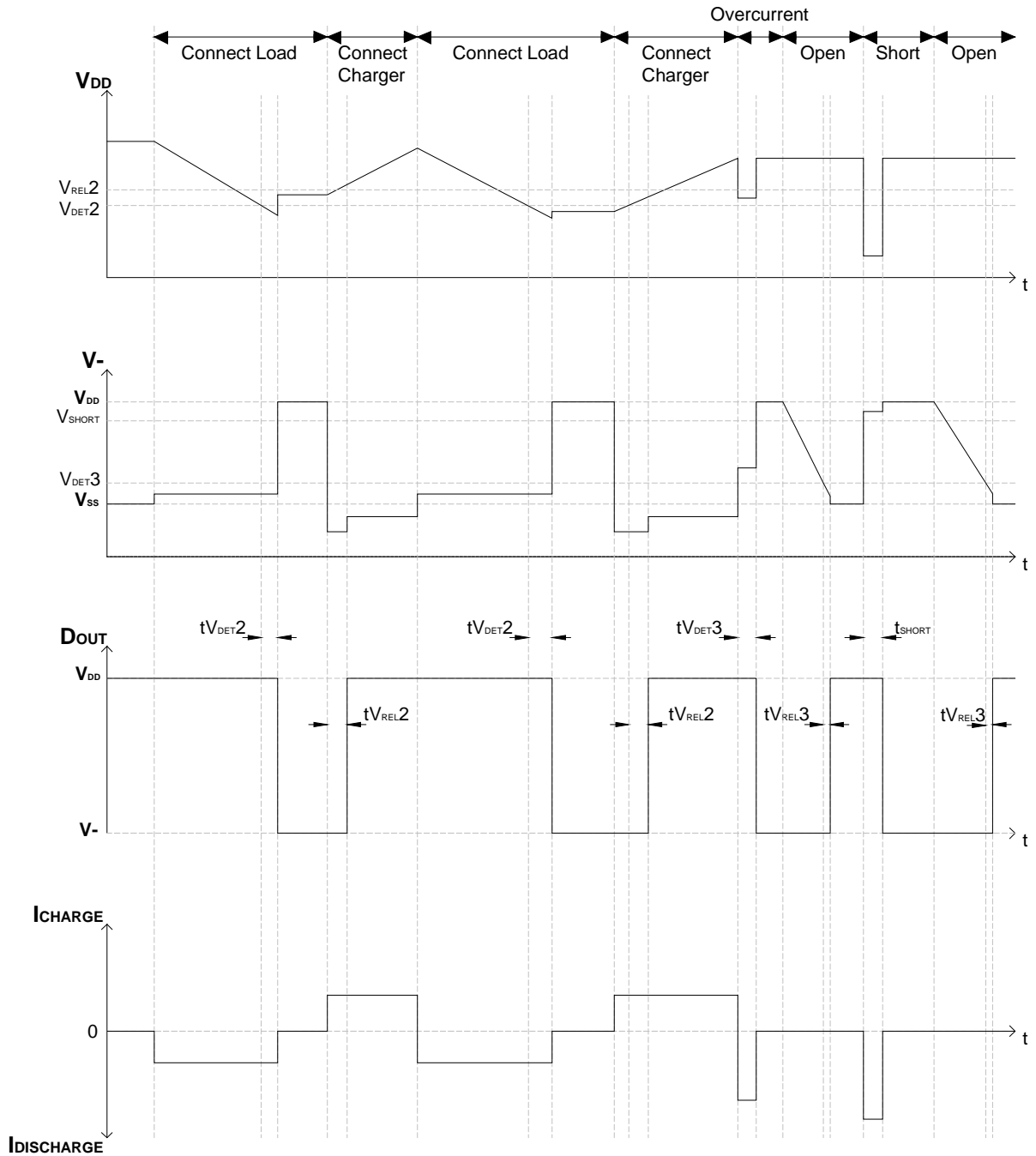
**2. Overdischarge, Discharging Overcurrent and Short operations**



**Battery Protect Solution IC**

**MP44A**

■ Packing spec

▷ Carrier tape spec

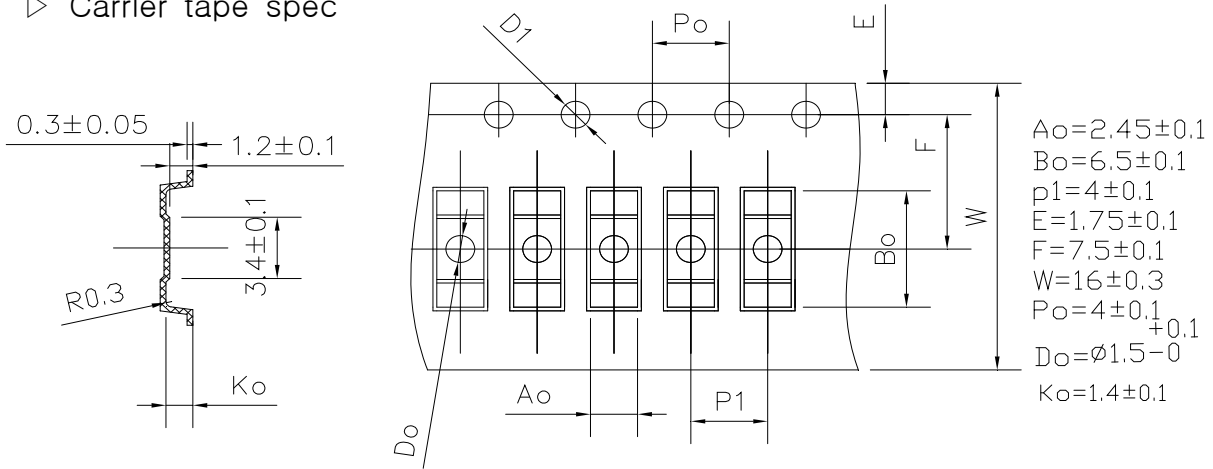

▷ Reel spec

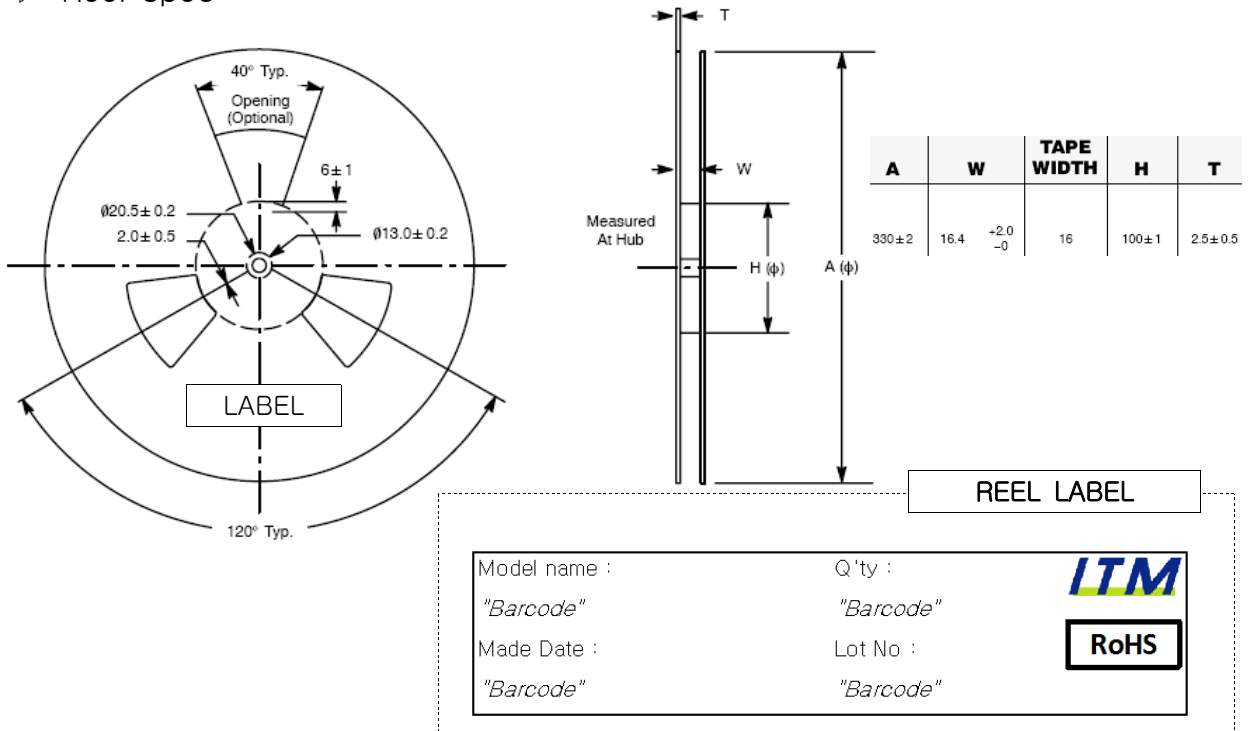

▷ Taping spec

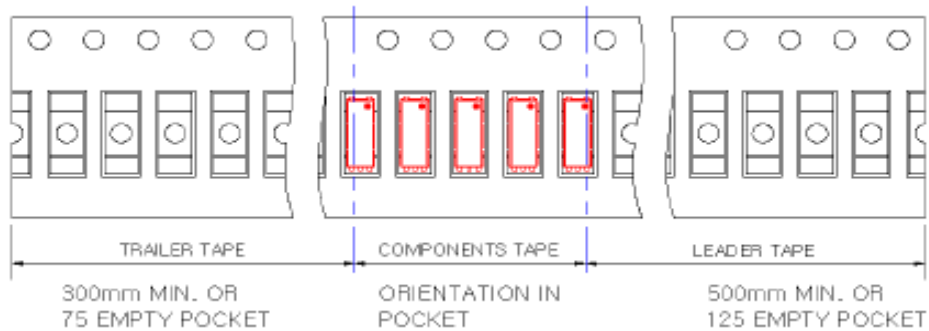

Battery Protect Solution IC

MP44A

▷ OUTER BOX PACKING SPECIFICATION

OUT BOX LABEL

	ITM Semiconductor Co., LTD
Model No :	Q'ty :
'Barcode'	'Barcode'
<b>Halogen free</b>	Ship Date :
Lot No :	'Barcode'
'Barcode'	

**RoHS**

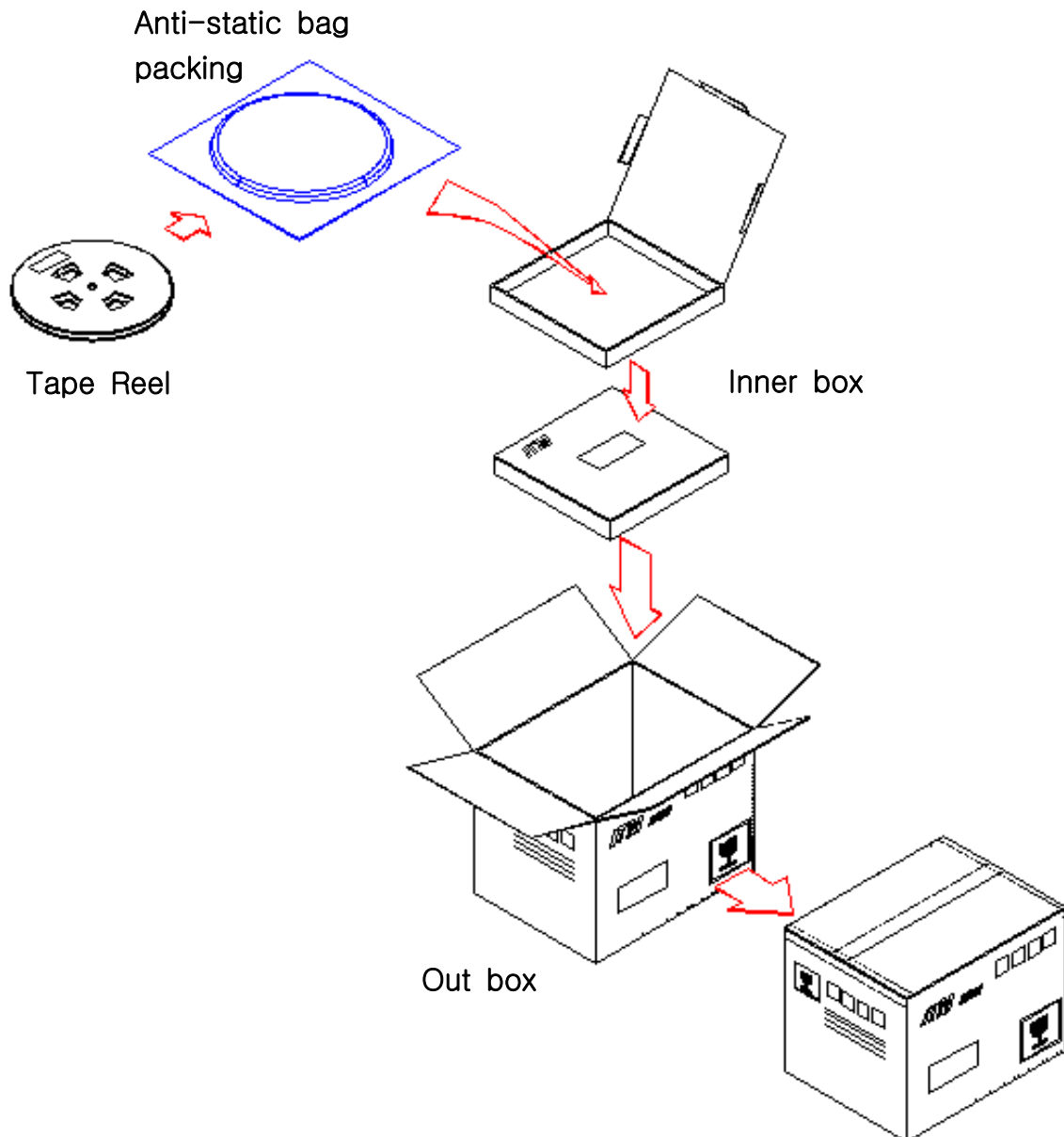

## Package Description

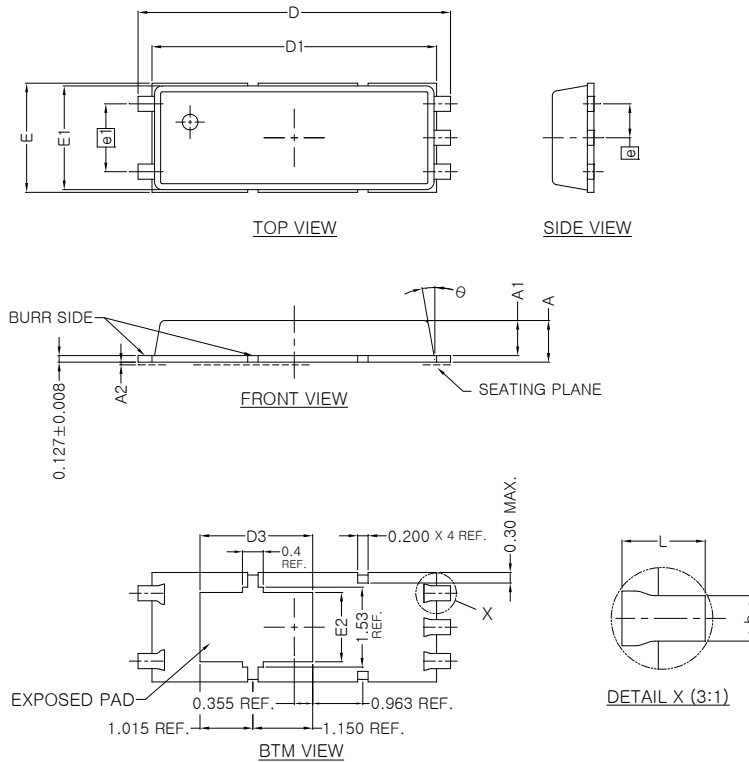

SYMBOL	DIMENSIONS			NOTE
	MIN.	NOM.	MAX.	
A	0.750	0.800	0.850	
A1	0.623	0.673	0.723	
A2	-	-	0.050	
D	5.900	6.000	6.100	
D1	5.320	5.370	5.420	
D3	2.220 REF.			
E	2.000	2.100	2.200	
E1	1.950	2.000	2.050	
E2	1.330 REF.			
$\theta$	-	-	10 °	
[e]	0.650 BSC			
[e1]	1.300 BSC			
L	0.350	-	-	
b	0.255	0.300	0.390	

**NOTE**

- LEAD BURR : VERTICAL MAX 0.025  
HORIZONTAL MAX 0.025  
BURR SIDE : ALL TOP SIDE
- MOLD BURR & FLASH : PACKAGE OUT LINE BURR MAX 0.100  
EXPOSED PAD FLASH MAX 0.200
- PACKAGE WARPAGE MAX 0.025
- LEAD AND EXPOSED PAD PLATING : PURE TIN  
THICKNESS > 7.62~25.4um

## Recommend Land Pattern

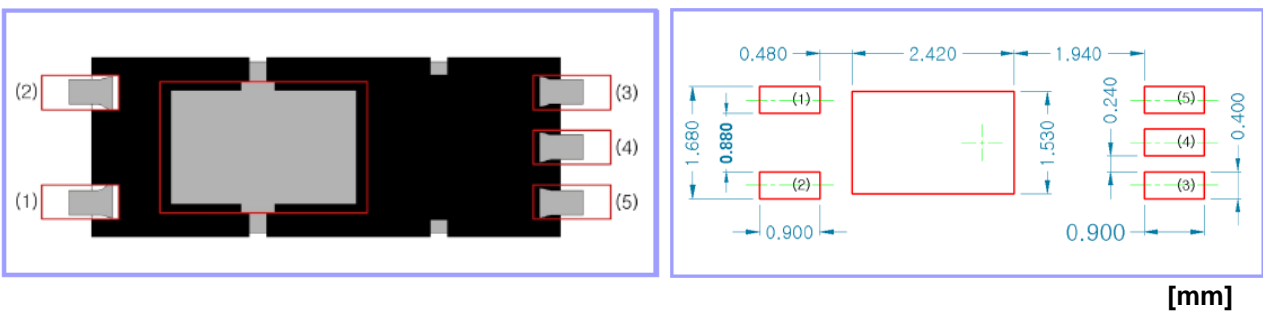

## Marking Contents

